



# YES LED Area Light

The YES LED Area Light, 170 lm/W, IP67 Wet Location Rated, Dimmable + Smart Inside

## FEATURES

<b>Lumen Output</b>	17000 to 51000 lumens
<b>Efficacy</b>	170 lm/W
<b>Input Voltage</b>	120-277V or 277-480V
<b>Dimmable</b>	0-10V Continuous
<b>CCT</b>	4000K or 5000K
<b>IP Rating</b>	IP67 Wet Location
<b>Impact Protection</b>	IK10 /20J
<b>Neutral Salt Spray /Fog Rating</b>	Grade 9
<b>Surge Protection</b>	3kV-6.6kV: LN, 5kV-10kV: LN-PE/N-PE
<b>Vibration Rating</b>	3g
<b>Warranty</b>	5 Years

## APPLICATIONS

Premium outdoor luminaire suitable for parking areas, auto dealerships, industrial yards, building exteriors, roadways, alleys, and pedestrian walkways.

## CONSTRUCTION

Manufactured for weather-proof durability using solid heavy duty die cast aluminum housing with anti-UV polyester coating to resist water, salt, corrosion, discoloration, and scratching. IP67 Wet Location rated for dust-tight, temporary immersion: IEC 60529. Impact Protection IK10, 20 joules: IEC 62262:2002. NSS, Neutral Salt Spray Rating Grade 9, 0<A≤1%: ASTM B117-2018/ASTM D1654-05. Vibration Acceleration Rating 3g: IEC 6008-2-6:1995.

## ELECTRICAL

Input voltages 120-277V or 277-480V models with 0-10V Continuous Dimming. Operating temperatures -4°F to 122°F (-20°C to 50°C). Surge Protection Rating 3kV-6.6kV: L-N, 5kV-10kV: L-PE/N-PE: IEC 61000-4-5.

## MOUNTING

Adjustable options include Slip-Fit, Round /Square Pole, and Trunnion Mounts.

## OPTICS

Anti-UV Clear Polycarbonate IES /NEMA Type III Lens standard. Type II, Type IV, Type V Lens, and Glare Shield available.

## CONTROLS

PIR Photocell, Bi-Level Dimming, and Motion Detection programmable twist-lock cap with Remote Control. Shorting Cap for manual switch or timer control.

## LISTINGS

DLC Premium listed. UL certified to meet US and Canadian standards. FCC, CE and RoHS compliant.

## WARRANTY

5 year exclusive limited warranty. View complete product warranty information

Project:
Date:
Catalog No:
Prepared By:

### 100W Models



### 150W, 200W Models



### 240W, 300W Models



### Slip-Fit Mount



### Trunnion Mount



### Square /Round Pole Mount



### Smart Sensor Cap



## CORRELATED COLOR TEMPERATURES (CCT)

4000K

5000K





## SPECIFICATIONS

## ENERGY DATA

Input Voltage: 120-277V, 277-480V

Input Frequency: 50/60 Hz

Wattage: 100W, 150W, 200W, 240W, 300W

Power Factor: &gt;0.9

Total Harmonic Distortion (THD): &lt;15%

Operating Temperature: -4°F to 122°F (-20°C to 50°C)

## LIGHTING DATA

Lumens: 17000 (100W), 25500 (150W), 34000 (200W), 40800 (240W), 51000 (300W)

Lumens Per Watt: 170 lm/W

Color Correlated Temperature (CCT): 4000K, 5000K

Dimmable: 0-10V

Color Rendering Index (CRI): &gt;70

L70: 75000 hours

## ORDERING INFORMATION

Model	Wattage	Voltage	Current	Lumens	Efficacy	CCT	Dimming	Color	Dimensions	Weight
YES-A02-100W-HY-4000K	100W	120-277V	0.83A@120V, 0.36A@277V	17000	170 lm/W	4000K	0-10V	Dark Bronze	13.14"L x 12.40"W x 2.55"H	10.40 lbs
YES-A02-100W-HY-5000K	100W	120-277V	0.83A@120V, 0.36A@277V	17000	170 lm/W	5000K	0-10V	Dark Bronze	13.14"L x 12.40"W x 2.55"H	10.40 lbs
YES-A01-100W-HY-HV-4000K	100W	277-480V	0.36A@277V, 0.21A@480V	17000	170 lm/W	4000K	0-10V	Dark Bronze	13.14"L x 12.40"W x 2.55"H	10.40 lbs
YES-A01-100W-HY-HV-5000K	100W	277-480V	0.36A@277V, 0.21A@480V	17000	170 lm/W	5000K	0-10V	Dark Bronze	13.14"L x 12.40"W x 2.55"H	10.40 lbs
YES-A04-150W-HY-4000K	150W	120-277V	1.25A@120V, 0.54A@277V	25500	170 lm/W	4000K	0-10V	Dark Bronze	17.91"L x 12.40"W x 2.55"H	11.00 lbs
YES-A04-150W-HY-5000K	150W	120-277V	1.25A@120V, 0.54A@277V	25500	170 lm/W	5000K	0-10V	Dark Bronze, White	17.91"L x 12.40"W x 2.55"H	11.00 lbs
YES-A03-150W-HY-HV-4000K	150W	277-480V	0.54A@277V, 0.31A@480V	25500	170 lm/W	4000K	0-10V	Dark Bronze	17.91"L x 12.40"W x 2.55"H	11.00 lbs
YES-A03-150W-HY-HV-5000K	150W	277-480V	0.54A@277V, 0.31A@480V	25500	170 lm/W	5000K	0-10V	Dark Bronze	17.91"L x 12.40"W x 2.55"H	11.00 lbs
YES-A05-200W-HY-4000K	200W	120-277V	1.67A@120V, 0.72A@277V	34000	170 lm/W	4000K	0-10V	Dark Bronze	17.91"L x 12.40"W x 2.55"H	14.30 lbs
YES-A05-200W-HY-5000K	200W	120-277V	1.67A@120V, 0.72A@277V	34000	170 lm/W	5000K	0-10V	Dark Bronze	17.91"L x 12.40"W x 2.55"H	14.30 lbs
YES-A07-240W-HY-4000K	240W	120-277V	2.00A@120V, 0.87A@277V	40800	170 lm/W	4000K	0-10V	Dark Bronze	22.79"L x 12.40"W x 2.55"H	14.60 lbs
YES-A07-240W-HY-5000K	240W	120-277V	2.00A@120V, 0.87A@277V	40800	170 lm/W	5000K	0-10V	Dark Bronze	22.79"L x 12.40"W x 2.55"H	14.60 lbs
YES-A06-240W-HY-HV-4000K	240W	277-480V	0.87A@277V, 0.50A@480V	40800	170 lm/W	4000K	0-10V	Dark Bronze	22.79"L x 12.40"W x 2.55"H	14.60 lbs
YES-A06-240W-HY-HV-5000K	240W	277-480V	0.87A@277V, 0.50A@480V	40800	170 lm/W	5000K	0-10V	Dark Bronze	22.79"L x 12.40"W x 2.55"H	14.60 lbs
YES-A09-300W-HY-H-4000K	300W	120-277V	2.50A@120V, 1.08A@277V	51000	170 lm/W	4000K	0-10V	Dark Bronze	22.79"L x 12.40"W x 2.55"H	19.40 lbs
YES-A09-300W-HY-H-5000K	300W	120-277V	2.50A@120V, 1.08A@277V	51000	170 lm/W	5000K	0-10V	Dark Bronze, White	22.79"L x 12.40"W x 2.55"H	19.40 lbs
YES-A08-300W-HY-HV-4000K	300W	277-480V	1.08A@277V, 0.63A@480V	51000	170 lm/W	4000K	0-10V	Dark Bronze	22.79"L x 12.40"W x 2.55"H	19.40 lbs
YES-A08-300W-HY-HV-5000K	300W	277-480V	1.08A@277V, 0.63A@480V	51000	170 lm/W	5000K	0-10V	Dark Bronze	22.79"L x 12.40"W x 2.55"H	19.40 lbs

Optics	Mount	Sensor	Accessory
T2 Type II Lens	A Slip-Fit (Adjustable)	ALPCSG2	Photocell Cap Sensor AGLS Glare Shield
T3 Type III Lens	B Square or Round Pole (Adjustable)	ALMSPCSG2	Photocell + Bi-Level Motion Dimming Sensor (Blank) None
T4 Type IV Lens	C Square Pole (Adjustable)	SC	Shorting Cap
T5 Type V Lens	D Trunnion Mount (Adjustable)		
	E None		

## ORDERING GUIDE

YES	A02	100W	HY	4000K	T3	A	ALPCSG2	AGLS
YES	Group	Wattage	Voltage	CCT	Lens	Mount	Sensor	Accessory





PHYSICAL DIMENSIONS

100W Models

13.14"L x 12.40"W x 2.55"H

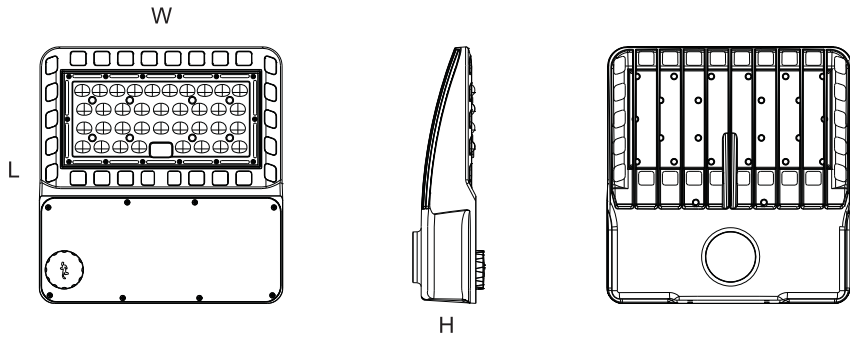

150W and 200W Models

17.91"L x 12.40"W x 2.55"H

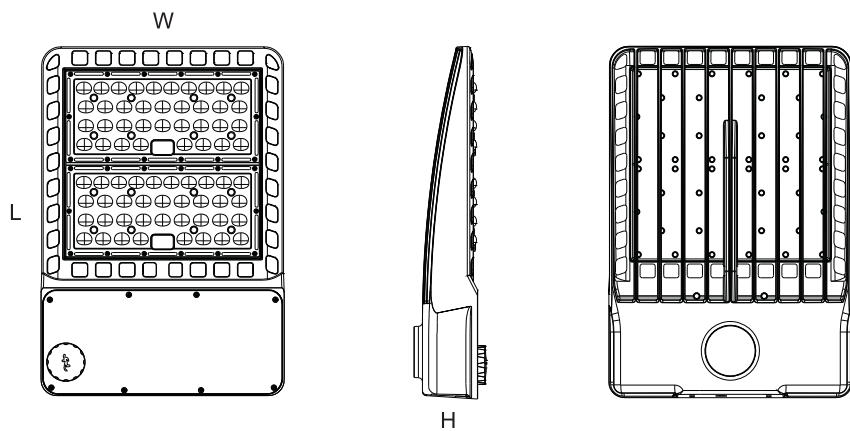

240W and 300W Models

22.79"L x 12.40"W x 2.55"H

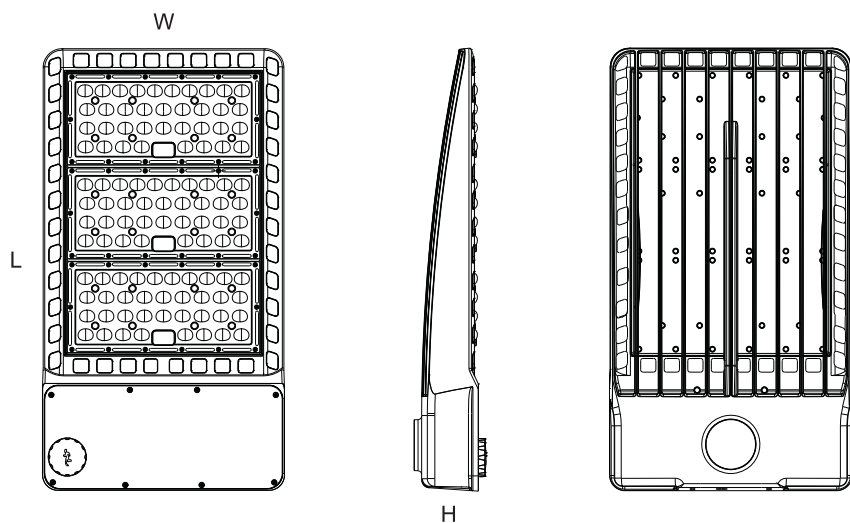

Slip-Fit Mount

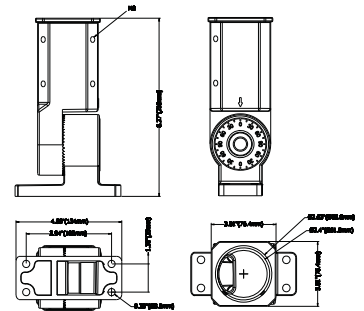

Round /Square Pole Mount

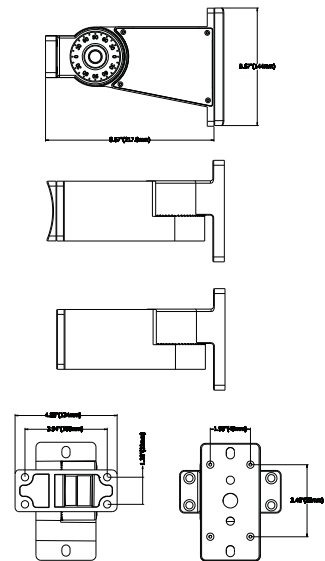

Trunnion Mount

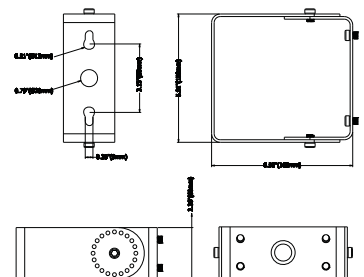



# YES LED Area Light

The YES LED Area Light, 170 lm/W, IP67 Wet  
Location Rated, Dimmable + Smart Inside

Project:
Date:
Catalog No:
Prepared By:

## FEATURES

<b>Lumen Output</b>	17000 to 51000 lumens
<b>Efficacy</b>	170 lm/W
<b>Input Voltage</b>	120-277V or 277-480V
<b>Dimmable</b>	0-10V Continuous
<b>CCT</b>	4000K or 5000K
<b>IP Rating</b>	IP67 Wet Location
<b>Impact Protection</b>	IK10 /20J
<b>Neutral Salt Spray /Fog Rating</b>	Grade 9
<b>Surge Protection</b>	3kV-6.6kV: LN, 5kV-10kV: LN-PE/N-PE
<b>Vibration Rating</b>	3g
<b>Warranty</b>	5 Years

### 100W Models



### 150W, 200W Models



### 240W, 300W Models



### Slip-Fit Mount



### Trunnion Mount



### Square /Round Pole Mount



### Smart Sensor Cap



### CORRELATED COLOR TEMPERATURES (CCT)

4000K

5000K



## APPLICATIONS

Premium outdoor luminaire suitable for parking areas, auto dealerships, industrial yards, building exteriors, roadways, alleys, and pedestrian walkways.

## CONSTRUCTION

Manufactured for weather-proof durability using solid heavy duty die cast aluminum housing with anti-UV polyester coating to resist water, salt, corrosion, discoloration, and scratching. IP67 Wet Location rated for dust-tight, temporary immersion: IEC 60529. Impact Protection IK10, 20 joules: IEC 62262:2002. NSS, Neutral Salt Spray Rating Grade 9, 0<A≤1%: ASTM B117-2018/ASTM D1654-05. Vibration Acceleration Rating 3g: IEC 6008-2-6:1995.

## ELECTRICAL

Input voltages 120-277V or 277-480V models with 0-10V Continuous Dimming. Operating temperatures -4°F to 122°F (-20°C to 50°C). Surge Protection Rating 3kV-6.6kV: L-N, 5kV-10kV: L-PE/N-PE: IEC 61000-4-5.

## MOUNTING

Adjustable options include Slip-Fit, Round /Square Pole, and Trunnion Mounts.

## OPTICS

Anti-UV Clear Polycarbonate IES /NEMA Type III Lens standard. Type II, Type IV, Type V Lens, and Glare Shield available.

## CONTROLS

PIR Photocell, Bi-Level Dimming, and Motion Detection programmable twist-lock cap with Remote Control. Shorting Cap for manual switch or timer control.

## LISTINGS

DLC Premium listed. UL certified to meet US and Canadian standards. FCC, CE and RoHS compliant.

## WARRANTY

5 year exclusive limited warranty. View complete product warranty information



**YES-A02-100W-HY-5000K (277V)**

Distribution: Nema Type III, Short, Cutoff

Lamp Output: 17383.9 lumens

Max Candela: 5798.0 at Horizontal: 67.5°, Vertical: 61°

Input Wattage: 100.52

Nema Type: 7 X 7

BUG: B3 U3 G3

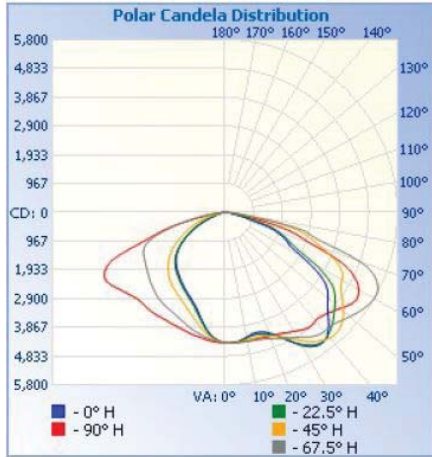

Distribution: Nema Type IV, Very Short, Semi-Cutoff

Lamp Output: 17358.8 lumens

Max Candela: 5616.1 at Horizontal: 337.5°, Vertical: 69°

Input Wattage: 101.07

Nema Type: 7 X 7

BUG: B3 U2 G2

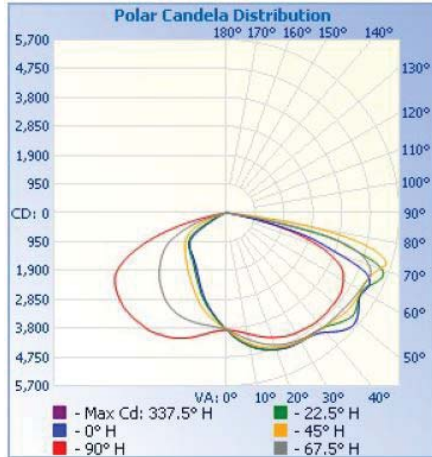

Distribution: Nema Type V, Very Short, Semi-Cutoff

Lamp Output: 17356.7 lumens

Max Candela: 4658.9 at Horizontal: 45°, Vertical: 70°

Input Wattage: 99.86

Nema Type: 7 X 7

BUG: B4 U2 G2

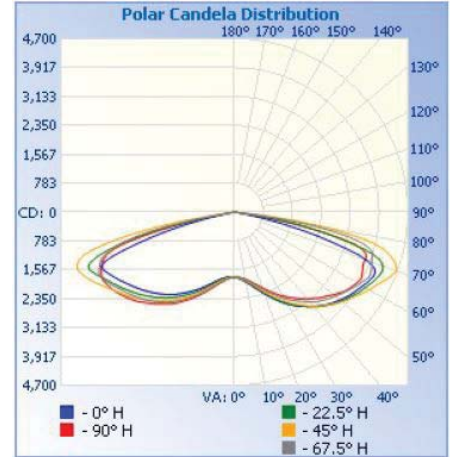

**ROADWAY SUMMARY**

Max Cd, 90° Vertical: 19.4

Max Cd, 80 to <90°: 2780.7

	Lumens	% Lamp
Downward Street Side	10565.3	60.8%
Downward House Side	6648.8	38.2%
<b>Downward Total</b>	<b>17214.1</b>	<b>99%</b>
Upward Street Side	88.6	0.5%
Upward House Side	81.3	0.5%
<b>Upward Total</b>	<b>169.8</b>	<b>1%</b>
<b>Total Lumens:</b>	<b>17383.9</b>	<b>100%</b>

Max Cd, 90° Vertical: 18.9

Max Cd, 80 to <90°: 3287.3

	Lumens	% Lamp
Downward Street Side	12195.6	70.3%
Downward House Side	5115.9	29.5%
<b>Downward Total</b>	<b>17311.4</b>	<b>99.7%</b>
Upward Street Side	21.3	0.1%
Upward House Side	26.1	0.2%
<b>Upward Total</b>	<b>47.4</b>	<b>0.3%</b>
<b>Total Lumens:</b>	<b>17358.8</b>	<b>100%</b>

Max Cd, 90° Vertical: 19.4

Max Cd, 80 to <90°: 2780.7

	Lumens	% Lamp
Downward Street Side	8982.4	51.8%
Downward House Side	8318.2	47.9%
<b>Downward Total</b>	<b>17300.6</b>	<b>99.7%</b>
Upward Street Side	30.5	0.2%
Upward House Side	25.6	0.1%
<b>Upward Total</b>	<b>56.1</b>	<b>0.3%</b>
<b>Total Lumens:</b>	<b>17356.7</b>	<b>100%</b>

**FLOOD SUMMARY**

	Efficacy	Lumens	Horiz. Spread	Vert. Spread
Field (10%)	97.4%	16929.9	159.2	152.5
Beam (50%)	77.9%	13548.1	139.9	112.7
<b>Total</b>	<b>99.9%</b>	<b>17375.6</b>		

	Efficacy	Lumens	Horiz. Spread	Vert. Spread
Field (10%)	98.7%	17127.7	130.7	143.2
Beam (50%)	82.3%	14278.9	114.6	95.9
<b>Total</b>	<b>99.9%</b>	<b>17347.4</b>		

	Efficacy	Lumens	Horiz. Spread	Vert. Spread
Field (10%)	99.2%	17219.1	143.6	162.8
Beam (50%)	90.4%	15692.2	130.1	153.3
<b>Total</b>	<b>99.9%</b>	<b>17341.9</b>		

**ILLUMINANCE**

Height	Center Beam fc	Beam Width	
17.0 ft	15.2 fc	51.1 ft	93.2 ft
34.0 ft	3.79 fc	102.1 ft	186.4 ft
51.0 ft	1.68 fc	153.2 ft	279.6 ft
68.0 ft	0.95 fc	204.2 ft	372.8 ft
85.0 ft	0.61 fc	255.3 ft	466.0 ft
102.0 ft	0.42 fc	306.3 ft	559.2 ft
		Vert. 112.7°	Horiz. 139.9°

Height	Center Beam fc	Beam Width	
17.0 ft	13.3 fc	37.7 ft	53.0 ft
34.0 ft	3.34 fc	75.4 ft	105.9 ft
51.0 ft	1.48 fc	113.1 ft	158.9 ft
68.0 ft	0.83 fc	150.8 ft	211.8 ft
85.0 ft	0.53 fc	188.5 ft	264.8 ft
102.0 ft	0.37 fc	226.2 ft	317.7 ft
		Vert. 95.9°	Horiz. 114.6°

Height	Center Beam fc	Beam Width	
17.0 ft	6.10 fc	143.3 ft	73.1 ft
34.0 ft	1.53 fc	286.7 ft	146.3 ft
51.0 ft	0.68 fc	430.0 ft	219.4 ft
68.0 ft	0.38 fc	573.3 ft	292.5 ft
85.0 ft	0.24 fc	716.6 ft	365.6 ft
102.0 ft	0.17 fc	860.0 ft	438.8 ft
		Vert. 153.3°	Horiz. 130.1°

**YES LED Area Light**



**YES-A01-100W-HY-HV-5000K (480V)**

Distribution: Nema Type III, Short, Cutoff

Lamp Output: 17341.9 lumens

Max Candela: 5807.0 at Horizontal: 67.5°, Vertical: 61°

Input Wattage: 99.78

Nema Type: 7 X 7

BUG: B3 U3 G3

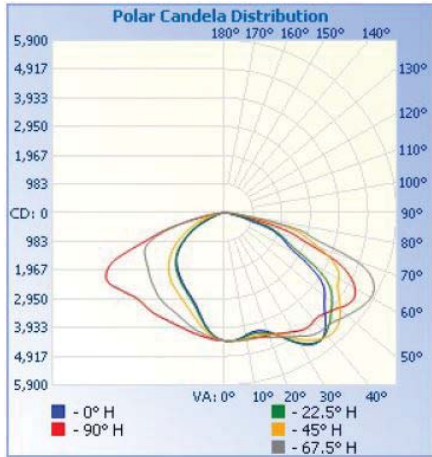

Distribution: Nema Type IV, Very Short, Semi-Cutoff

Lamp Output: 17337.5 lumens

Max Candela: 5609.9 at Horizontal: 337.5°, Vertical: 69°

Input Wattage: 100.57

Nema Type: 7 X 7

BUG: B3 U2 G2

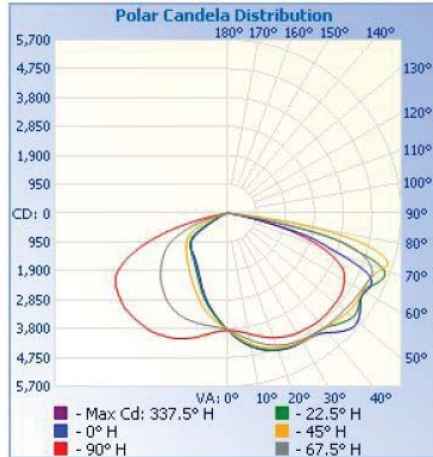

Distribution: Nema Type V, Very Short, Semi-Cutoff

Lamp Output: 17368 lumens

Max Candela: 4681.8 at Horizontal: 45°, Vertical: 70°

Input Wattage: 99.33

Nema Type: 7 X 7

BUG: B4 U2 G2

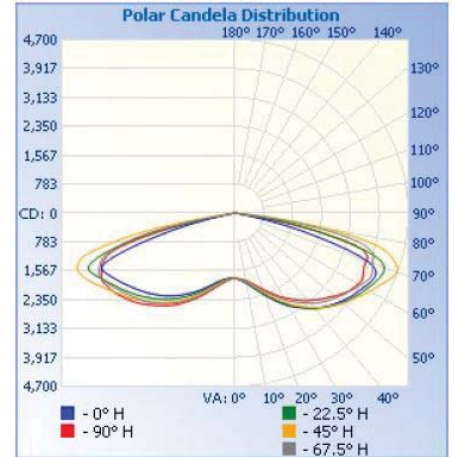

**ROADWAY SUMMARY**

Max Cd, 90° Vertical: 173.9

Max Cd, 80 to <90°: 1300.5

	Lumens	% Lamp
Downward Street Side	10538.6	60.8%
Downward House Side	6633.3	38.3%
<b>Downward Total</b>	<b>17171.9</b>	<b>99%</b>
Upward Street Side	88.8	0.5%
Upward House Side	81.2	0.5%
<b>Upward Total</b>	<b>170.0</b>	<b>1%</b>
<b>Total Lumens:</b>	<b>17342.0</b>	<b>100%</b>

Max Cd, 90° Vertical: 18.0

Max Cd, 80 to <90°: 3277.4

	Lumens	% Lamp
Downward Street Side	12118.1	70.3%
Downward House Side	5102.9	29.4%
<b>Downward Total</b>	<b>17291.0</b>	<b>99.7%</b>
Upward Street Side	20.9	0.1%
Upward House Side	25.6	0.1%
<b>Upward Total</b>	<b>46.5</b>	<b>0.3%</b>
<b>Total Lumens:</b>	<b>17337.5</b>	<b>100%</b>

Max Cd, 90° Vertical: 18.7

Max Cd, 80 to <90°: 2754.8

	Lumens	% Lamp
Downward Street Side	8964.8	51.6%
Downward House Side	8347.9	48.1%
<b>Downward Total</b>	<b>17312.7</b>	<b>99.7%</b>
Upward Street Side	30.1	0.2%
Upward House Side	25.1	0.1%
<b>Upward Total</b>	<b>55.2</b>	<b>0.3%</b>
<b>Total Lumens:</b>	<b>17368.0</b>	<b>100%</b>

**FLOOD SUMMARY**

	Efficacy	Lumens	Horiz. Spread	Vert. Spread
Field (10%)	97.4%	16882.5	159.0	152.5
Beam (50%)	77.8%	13485.5	139.5	112
<b>Total</b>	<b>99.9%</b>	<b>17332.8</b>		

	Efficacy	Lumens	Horiz. Spread	Vert. Spread
Field (10%)	98.7%	17108.2	130.7	143.2
Beam (50%)	82.3%	14270.7	114.6	95.9
<b>Total</b>	<b>99.9%</b>	<b>17326.3</b>		

	Efficacy	Lumens	Horiz. Spread	Vert. Spread
Field (10%)	99.2%	17228.4	140.4	162.8
Beam (50%)	90.4%	15695.9	126.7	153.2
<b>Total</b>	<b>99.9%</b>	<b>17353.0</b>		

**ILLUMINANCE**

Height	Center Beam fc	Beam Width	
17.0 ft	15.2 fc	50.4 ft	92.1 ft
34.0 ft	3.79 fc	100.9 ft	184.2 ft
51.0 ft	1.68 fc	151.3 ft	276.3 ft
68.0 ft	0.95 fc	201.7 ft	368.4 ft
85.0 ft	0.61 fc	252.1 ft	460.5 ft
102.0 ft	0.42 fc	302.6 ft	552.6 ft
		Vert. 112.0°	Horiz. 139.5°

Height	Center Beam fc	Beam Width	
17.0 ft	13.3 fc	37.7 ft	53.0 ft
34.0 ft	3.33 fc	75.4 ft	106.0 ft
51.0 ft	1.48 fc	113.1 ft	159.0 ft
68.0 ft	0.83 fc	150.8 ft	212.0 ft
85.0 ft	0.53 fc	188.5 ft	265.0 ft
102.0 ft	0.37 fc	226.2 ft	318.0 ft
		Vert. 95.9°	Horiz. 114.6°

Height	Center Beam fc	Beam Width	
17.0 ft	6.13 fc	142.7 ft	67.7 ft
34.0 ft	1.53 fc	285.4 ft	135.4 ft
51.0 ft	0.68 fc	428.1 ft	203.1 ft
68.0 ft	0.38 fc	570.8 ft	270.8 ft
85.0 ft	0.25 fc	713.5 ft	338.5 ft
102.0 ft	0.17 fc	856.2 ft	406.3 ft
		Vert. 153.2°	Horiz. 126.7°

**YES LED Area Light**



**YES-A04-150W-HY-5000K (277V)**

Distribution: Nema Type III, Short, Cutoff

Lamp Output: 25911.5 lumens

Max Candela: 8729.6 at Horizontal: 67.5°, Vertical: 62°

Input Wattage: 149.38

Nema Type: 7 X 7

BUG: B4 U3 G3

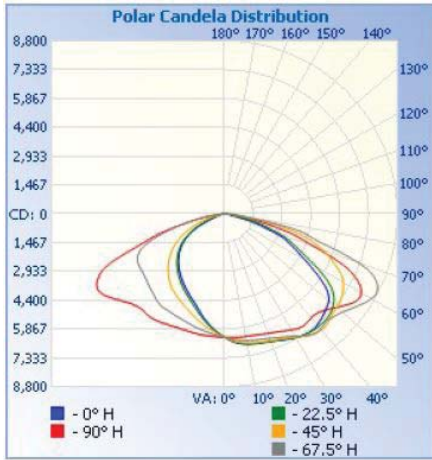

Distribution: Nema Type IV, Very Short, Non-Cutoff

Lamp Output: 25957.6 lumens

Max Candela: 8372.0 at Horizontal: 337.5°, Vertical: 69°

Input Wattage: 150.14

Nema Type: 7 X 7

BUG: B3 U3 G3

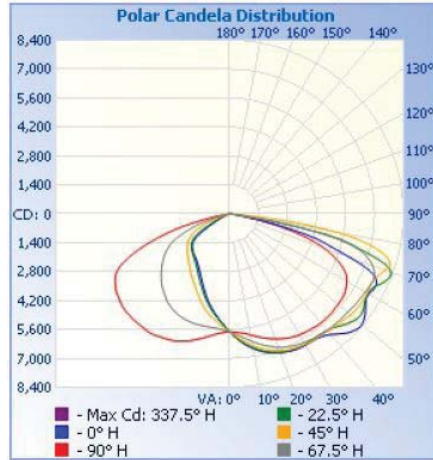

Distribution: Nema Type V, Very Short, Semi-Cutoff

Lamp Output: 26090.8 lumens

Max Candela: 6953.0 at Horizontal: 135°, Vertical: 70°

Input Wattage: 149.93

Nema Type: 7 X 7

BUG: B5 U3 G3

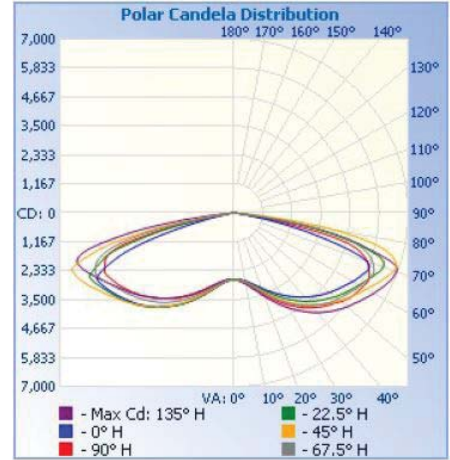

**ROADWAY SUMMARY**

Max Cd, 90° Vertical: 276.7

Max Cd, 80 to <90°: 1871.9

	Lumens	% Lamp
Downward Street Side	15829.3	61.1%
Downward House Side	9876.3	38.1%
<b>Downward Total</b>	<b>25705.6</b>	<b>99.2%</b>
Upward Street Side	104.2	0.4%
Upward House Side	101.7	0.4%
<b>Upward Total</b>	<b>206.0</b>	<b>0.8%</b>
<b>Total Lumens:</b>	<b>25911.5</b>	<b>100%</b>

Max Cd, 90° Vertical: 29.4

Max Cd, 80 to <90°: 5466.6

	Lumens	% Lamp
Downward Street Side	18369.8	70.8%
Downward House Side	7515.7	29%
<b>Downward Total</b>	<b>25885.5</b>	<b>99.7%</b>
Upward Street Side	32.4	0.1%
Upward House Side	39.8	0.2%
<b>Upward Total</b>	<b>72.2</b>	<b>0.3%</b>
<b>Total Lumens:</b>	<b>25957.6</b>	<b>100%</b>

Max Cd, 90° Vertical: 38.4

Max Cd, 80 to <90°: 4363.9

	Lumens	% Lamp
Downward Street Side	12954.9	49.7%
Downward House Side	13000.9	49.8%
<b>Downward Total</b>	<b>25955.8</b>	<b>99.5%</b>
Upward Street Side	72.2	0.3%
Upward House Side	62.9	0.2%
<b>Upward Total</b>	<b>135.0</b>	<b>0.5%</b>
<b>Total Lumens:</b>	<b>26090.8</b>	<b>100%</b>

**FLOOD SUMMARY**

	Efficacy	Lumens	Horiz. Spread	Vert. Spread
Field (10%)	97.6%	25285.8	159.2	149.6
Beam (50%)	78.4%	20325.4	138.9	111.5
<b>Total</b>	<b>100%</b>	<b>25900.1</b>		

	Efficacy	Lumens	Horiz. Spread	Vert. Spread
Field (10%)	98.7%	25614.9	149.9	140.8
Beam (50%)	82.3%	21371.6	137.0	89.8
<b>Total</b>	<b>99.9%</b>	<b>25940.9</b>		

	Efficacy	Lumens	Horiz. Spread	Vert. Spread
Field (10%)	98.9%	25814.1	141.8	162.7
Beam (50%)	90.4%	23575.3	127.2	152.4
<b>Total</b>	<b>99.9%</b>	<b>26069.1</b>		

**ILLUMINANCE**

Height	Center Beam fc	Beam Width	Vert. Spread	Horiz. Spread
17.0 ft	21.7 fc	49.9 ft	90.8 ft	
34.0 ft	5.43 fc	99.8 ft	181.5 ft	
51.0 ft	2.41 fc	149.7 ft	272.3 ft	
68.0 ft	1.36 fc	199.6 ft	363.1 ft	
85.0 ft	0.87 fc	249.5 ft	453.8 ft	
102.0 ft	0.60 fc	299.5 ft	544.6 ft	
			Vert. 111.5°	Horiz. 138.9°

Height	Center Beam fc	Beam Width	Vert. Spread	Horiz. Spread
17.0 ft	19.7 fc	33.9 ft	86.4 ft	
34.0 ft	4.93 fc	67.7 ft	172.7 ft	
51.0 ft	2.19 fc	101.6 ft	259.1 ft	
68.0 ft	1.23 fc	135.5 ft	345.5 ft	
85.0 ft	0.79 fc	169.3 ft	431.9 ft	
102.0 ft	0.55 fc	203.2 ft	518.2 ft	
			Vert. 89.8°	Horiz. 137.0°

Height	Center Beam fc	Beam Width	Vert. Spread	Horiz. Spread
17.0 ft	9.29 fc	138.6 ft	68.4 ft	
34.0 ft	2.32 fc	277.3 ft	136.9 ft	
51.0 ft	1.03 fc	415.9 ft	205.3 ft	
68.0 ft	0.58 fc	554.5 ft	273.8 ft	
85.0 ft	0.37 fc	693.2 ft	342.2 ft	
102.0 ft	0.26 fc	831.8 ft	410.7 ft	
			Vert. 152.4°	Horiz. 127.2°

**YES LED Area Light**



**YES-A03-150W-HY-HV-5000K (480V)**

Distribution: Nema Type III, Short, Cutoff

Lamp Output: 25848.9 lumens

Max Candela: 8703.0 at Horizontal: 67.5°, Vertical: 62°

Input Wattage: 148.27

Nema Type: 7 X 7

BUG: B4 U3 G3

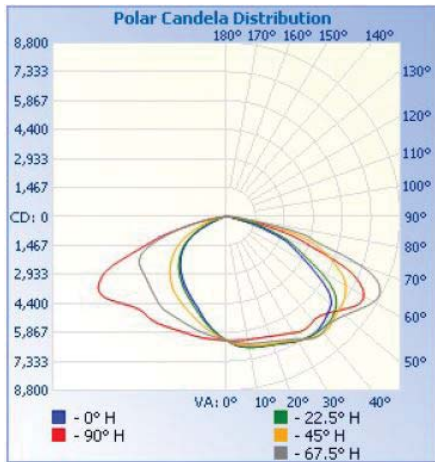

Distribution: Nema Type IV, Very Short, Non-Cutoff

Lamp Output: 25925.8 lumens

Max Candela: 8354.8 at Horizontal: 337.5°, Vertical: 69°

Input Wattage: 149.4

Nema Type: 7 X 7

BUG: B3 U3 G3

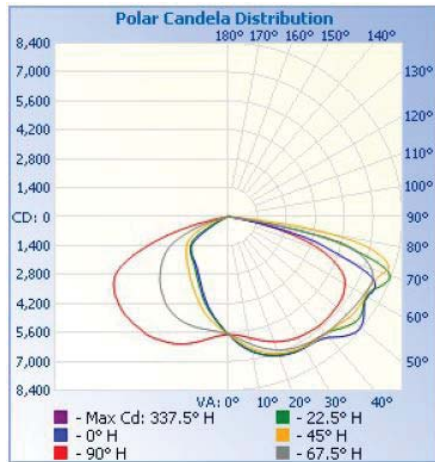

Distribution: Nema Type V, Very Short, Semi-Cutoff

Lamp Output: 26107.7 lumens

Max Candela: 6949.7 at Horizontal: 135°, Vertical: 70°

Input Wattage: 149.14

Nema Type: 7 X 7

BUG: B5 U3 G3

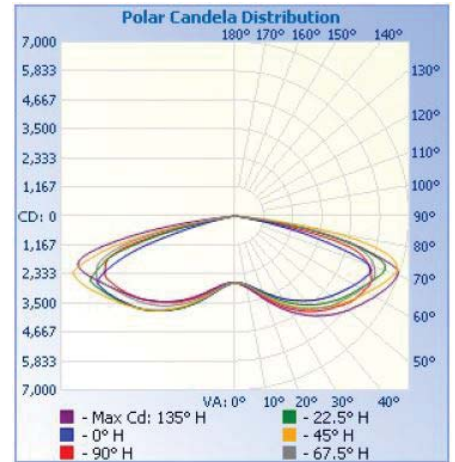

**ROADWAY SUMMARY**

Max Cd, 90° Vertical: 273.6

Max Cd, 80 to <90°: 1883.0

	Lumens	% Lamp
Downward Street Side	15801.0	61.1%
Downward House Side	9856.2	38.1%
<b>Downward Total</b>	<b>25657.1</b>	<b>99.3%</b>
Upward Street Side	97.4	0.4%
Upward House Side	94.4	0.4%
<b>Upward Total</b>	<b>191.8</b>	<b>0.7%</b>
<b>Total Lumens:</b>	<b>25848.9</b>	<b>100%</b>

Max Cd, 90° Vertical: 29.8

Max Cd, 80 to <90°: 5421.0

	Lumens	% Lamp
Downward Street Side	18349.8	70.8%
Downward House Side	7503.5	28.9%
<b>Downward Total</b>	<b>25853.3</b>	<b>99.7%</b>
Upward Street Side	32.8	0.1%
Upward House Side	39.8	0.2%
<b>Upward Total</b>	<b>72.5</b>	<b>0.3%</b>
<b>Total Lumens:</b>	<b>25925.9</b>	<b>100%</b>

Max Cd, 90° Vertical: 37.0

Max Cd, 80 to <90°: 4371.5

	Lumens	% Lamp
Downward Street Side	12927.2	49.7%
Downward House Side	13017.3	49.9%
<b>Downward Total</b>	<b>25989.4</b>	<b>99.5%</b>
Upward Street Side	62.8	0.2%
Upward House Side	55.4	0.2%
<b>Upward Total</b>	<b>118.3</b>	<b>0.5%</b>
<b>Total Lumens:</b>	<b>26107.7</b>	<b>100%</b>

**FLOOD SUMMARY**

	Efficacy	Lumens	Horiz. Spread	Vert. Spread
Field (10%)	97.6%	25240.1	159.2	149.6
Beam (50%)	78.6%	20313.2	139.0	111.6
<b>Total</b>	<b>100%</b>	<b>25837.9</b>		

	Efficacy	Lumens	Horiz. Spread	Vert. Spread
Field (10%)	98.7%	25580.4	149.9	140.8
Beam (50%)	82.3%	21341.5	136.9	89.7
<b>Total</b>	<b>99.9%</b>	<b>25907.9</b>		

	Efficacy	Lumens	Horiz. Spread	Vert. Spread
Field (10%)	99.0%	25847.1	141.5	162.6
Beam (50%)	90.5%	23627.8	126.9	152.3
<b>Total</b>	<b>99.9%</b>	<b>26085.3</b>		

**ILLUMINANCE**

Height	Center Beam fc	Beam Width	
17.0 ft	21.7 fc	50.0 ft	90.9 ft
34.0 ft	5.42 fc	100.0 ft	181.7 ft
51.0 ft	2.41 fc	150.0 ft	272.6 ft
68.0 ft	1.36 fc	200.0 ft	363.4 ft
85.0 ft	0.87 fc	250.0 ft	454.3 ft
102.0 ft	0.60 fc	299.9 ft	545.2 ft
		Vert. 111.6°	Horiz. 139.0°

Height	Center Beam fc	Beam Width	
17.0 ft	19.7 fc	33.8 ft	86.2 ft
34.0 ft	4.93 fc	67.6 ft	172.3 ft
51.0 ft	2.19 fc	101.5 ft	258.5 ft
68.0 ft	1.23 fc	135.3 ft	344.7 ft
85.0 ft	0.79 fc	169.1 ft	430.8 ft
102.0 ft	0.55 fc	202.9 ft	517.0 ft
		Vert. 89.7°	Horiz. 136.9°

Height	Center Beam fc	Beam Width	
17.0 ft	9.30 fc	137.9 ft	68.1 ft
34.0 ft	2.32 fc	275.8 ft	136.1 ft
51.0 ft	1.03 fc	413.7 ft	204.2 ft
68.0 ft	0.58 fc	551.6 ft	272.2 ft
85.0 ft	0.37 fc	689.5 ft	340.3 ft
102.0 ft	0.26 fc	827.4 ft	408.3 ft
		Vert. 152.3°	Horiz. 126.9°

**YES LED Area Light**





**YES-A05-200W-HY-5000K (277V)**

Distribution: Nema Type III, Short, Cutoff

Lamp Output: 34755.6 lumens

Max Candela: 11704.5 at Horizontal: 67.5°, Vertical: 63°

Input Wattage: 202.15

Nema Type: 7 X 7

BUG: B4 U3 G4

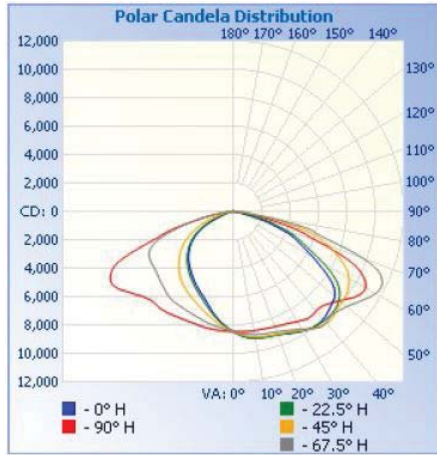

Distribution: Nema Type IV, Very Short, Non-Cutoff

Lamp Output: 34458.9 lumens

Max Candela: 10647.6 at Horizontal: 292.5°, Vertical: 57°

Input Wattage: 201.88

Nema Type: 7 X 7

BUG: B4 U3 G5

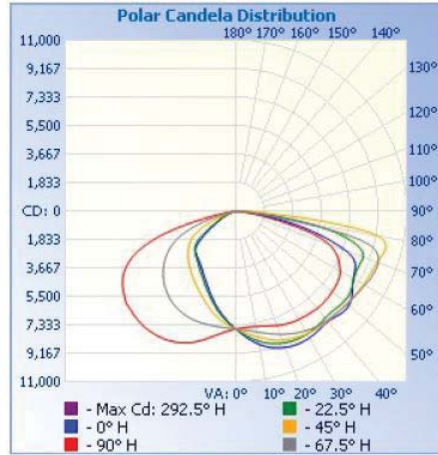

Distribution: Nema Type V, Very Short, Non-Cutoff

Lamp Output: 34715.6 lumens

Max Candela: 9267.4 at Horizontal: 225°, Vertical: 72°

Input Wattage: 200.97

Nema Type: 7 X 7

BUG: B5 U3 G4

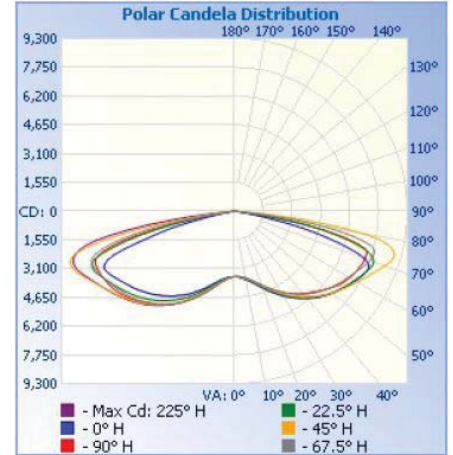

**ROADWAY SUMMARY**

Max Cd, 90° Vertical: 369.1

Max Cd, 80 to <90°: 2613.5

	Lumens	% Lamp
Downward Street Side	21278.7	61.2%
Downward House Side	13252.0	38.1%
<b>Downward Total</b>	<b>34530.7</b>	<b>99.4%</b>
Upward Street Side	115.7	0.3%
Upward House Side	109.2	0.3%
<b>Upward Total</b>	<b>224.9</b>	<b>0.6%</b>
Total Lumens:	34755.6	100%

Max Cd, 90° Vertical: 122.7

Max Cd, 80 to <90°: 9361.1

	Lumens	% Lamp
Downward Street Side	24177.8	70.2%
Downward House Side	10151.4	29.5%
<b>Downward Total</b>	<b>34329.2</b>	<b>99.6%</b>
Upward Street Side	61.4	0.2%
Upward House Side	68.3	0.2%
<b>Upward Total</b>	<b>129.6</b>	<b>0.4%</b>
Total Lumens:	34458.9	100%

Max Cd, 90° Vertical: 43.7

Max Cd, 80 to <90°: 7114.5

	Lumens	% Lamp
Downward Street Side	17596.1	50.7%
Downward House Side	16978.3	48.9%
<b>Downward Total</b>	<b>34574.5</b>	<b>99.6%</b>
Upward Street Side	74.8	0.2%
Upward House Side	66.3	0.2%
<b>Upward Total</b>	<b>141.1</b>	<b>0.4%</b>
Total Lumens:	34715.6	100%

**FLOOD SUMMARY**

	Efficacy	Lumens	Horiz. Spread	Vert. Spread
Field (10%)	97.8%	33990.5	159.5	150.1
Beam (50%)	78.6%	27334.9	139.4	112.4
<b>Total</b>	<b>100%</b>	<b>34739.8</b>		

	Efficacy	Lumens	Horiz. Spread	Vert. Spread
Field (10%)	98.5%	33934.2	158.7	144.2
Beam (50%)	82.7%	28499.6	146.3	107.2
<b>Total</b>	<b>99.9%</b>	<b>34433.5</b>		

	Efficacy	Lumens	Horiz. Spread	Vert. Spread
Field (10%)	99.1%	34398.1	142.2	162.7
Beam (50%)	90.0%	31248.6	126.6	153.3
<b>Total</b>	<b>99.9%</b>	<b>34682.9</b>		

**ILLUMINANCE**

Height	Center Beam fc	Beam Width	
17.0 ft	29.3 fc	50.8 ft	91.9 ft
34.0 ft	7.32 fc	101.5 ft	183.8 ft
51.0 ft	3.25 fc	152.3 ft	275.7 ft
68.0 ft	1.83 fc	203.0 ft	367.6 ft
85.0 ft	1.17 fc	253.8 ft	459.5 ft
102.0 ft	0.81 fc	304.5 ft	551.3 ft
		Vert. 112.4°	Horiz. 139.4°

Height	Center Beam fc	Beam Width	
17.0 ft	26.3 fc	46.1 ft	112.3 ft
34.0 ft	6.58 fc	92.1 ft	224.5 ft
51.0 ft	2.92 fc	138.2 ft	336.8 ft
68.0 ft	1.64 fc	184.3 ft	449.0 ft
85.0 ft	1.05 fc	230.4 ft	561.3 ft
102.0 ft	0.73 fc	276.4 ft	673.5 ft
		Vert. 107.2°	Horiz. 146.3°

Height	Center Beam fc	Beam Width	
17.0 ft	12.2 fc	143.0 ft	67.7 ft
34.0 ft	3.05 fc	286.1 ft	135.3 ft
51.0 ft	1.36 fc	429.1 ft	203.0 ft
68.0 ft	0.76 fc	572.1 ft	270.6 ft
85.0 ft	0.49 fc	715.2 ft	338.3 ft
102.0 ft	0.34 fc	858.2 ft	405.9 ft
		Vert. 153.3°	Horiz. 126.6°

**YES LED Area Light**



YES-A07-240W-HY-5000K (277V)

Distribution: Nema Type III, Short, Cutoff

Lamp Output: 42165.7 lumens

Max Candela: 13777.7 at Horizontal: 67.5°, Vertical: 61°

Input Wattage: 243.38

Nema Type: 7 X 7

BUG: B4 U3 G4

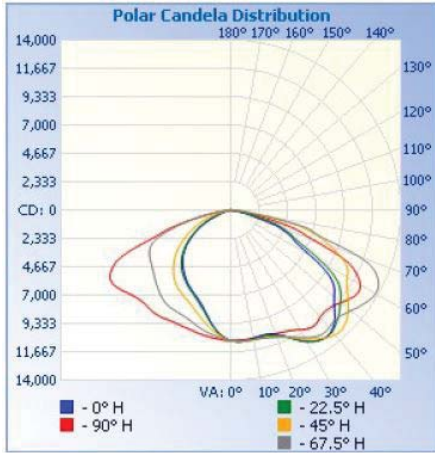

Distribution: Nema Type IV, Very Short, Non-Cutoff

Lamp Output: 41840.4 lumens

Max Candela: 12947.8 at Horizontal: 292.5°, Vertical: 55°

Input Wattage: 242.75

Nema Type: 7 X 7

BUG: B4 U3 G5

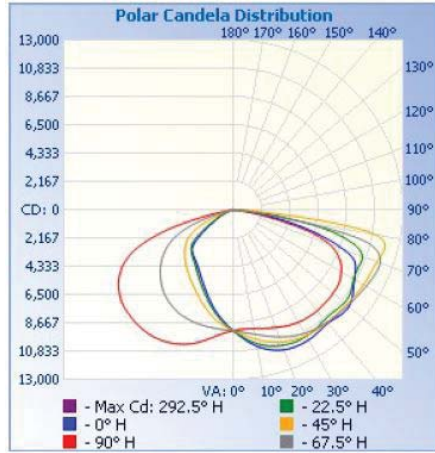

Distribution: Nema Type V, Very Short, Non-Cutoff

Lamp Output: 42111 lumens

Max Candela: 11241.6 at Horizontal: 225°, Vertical: 72°

Input Wattage: 241.92

Nema Type: 7 X 7

BUG: B5 U3 G4

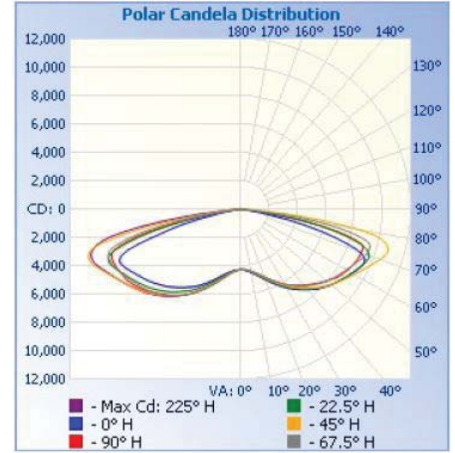

ROADWAY SUMMARY

Max Cd, 90° Vertical: 343.3

Max Cd, 80 to <90°: 3389.2

Table with 3 columns: Direction, Lumens, % Lamp. Rows include Downward Street Side, Downward House Side, Downward Total, Upward Street Side, Upward House Side, Upward Total, and Total Lumens.

Max Cd, 90° Vertical: 94.9

Max Cd, 80 to <90°: 11146.8

Table with 3 columns: Direction, Lumens, % Lamp. Rows include Downward Street Side, Downward House Side, Downward Total, Upward Street Side, Upward House Side, Upward Total, and Total Lumens.

Max Cd, 90° Vertical: 53.0

Max Cd, 80 to <90°: 8630.1

Table with 3 columns: Direction, Lumens, % Lamp. Rows include Downward Street Side, Downward House Side, Downward Total, Upward Street Side, Upward House Side, Upward Total, and Total Lumens.

FLOOD SUMMARY

Table with 5 columns: Efficacy, Lumens, Horiz. Spread, Vert. Spread. Rows include Field (10%), Beam (50%), and Total.

Table with 5 columns: Efficacy, Lumens, Horiz. Spread, Vert. Spread. Rows include Field (10%), Beam (50%), and Total.

Table with 5 columns: Efficacy, Lumens, Horiz. Spread, Vert. Spread. Rows include Field (10%), Beam (50%), and Total.

ILLUMINANCE

Table with 4 columns: Height, Center Beam fc, Beam Width, and a sub-table for Vert. and Horiz. spread.

Table with 4 columns: Height, Center Beam fc, Beam Width, and a sub-table for Vert. and Horiz. spread.

Table with 4 columns: Height, Center Beam fc, Beam Width, and a sub-table for Vert. and Horiz. spread.

YES LED Area Light



**YES-A06-240W-HY-HV-5000K (480V)**

Distribution: Nema Type III, Short, Cutoff

Lamp Output: 42063.6 lumens

Max Candela: 13766.3 at Horizontal: 67.5°, Vertical: 61°

Input Wattage: 241.58

Nema Type: 7 X 7

BUG: B4 U3 G4

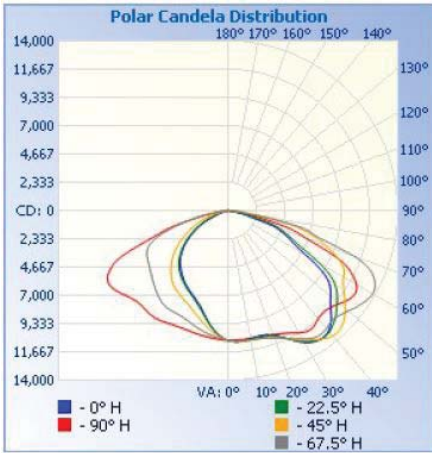

Distribution: Nema Type IV, Very Short, Non-Cutoff

Lamp Output: 41789.1 lumens

Max Candela: 12932.0 at Horizontal: 292.5°, Vertical: 55°

Input Wattage: 241.55

Nema Type: 7 X 7

BUG: B4 U3 G5

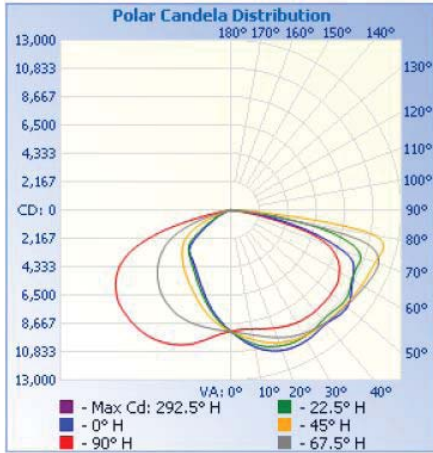

Distribution: Nema Type V, Very Short, Non-Cutoff

Lamp Output: 42138.2 lumens

Max Candela: 11234.6 at Horizontal: 225°, Vertical: 72°

Input Wattage: 240.64

Nema Type: 7 X 7

BUG: B5 U3 G4

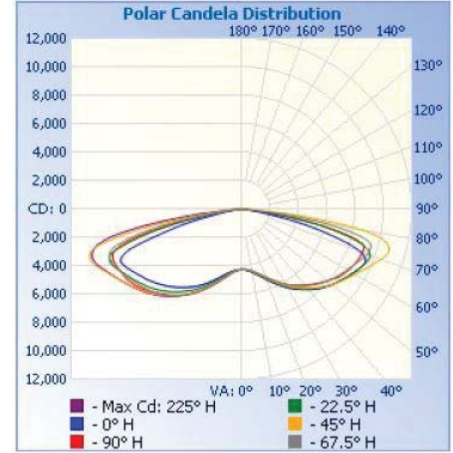

**ROADWAY SUMMARY**

Max Cd, 90° Vertical: 340.1

Max Cd, 80 to <90°: 3259.8

	Lumens	% Lamp
Downward Street Side	25932.8	61.7%
Downward House Side	15919.0	37.8%
<b>Downward Total</b>	<b>41851.8</b>	<b>99.5%</b>
Upward Street Side	110.2	0.3%
Upward House Side	101.5	0.2%
<b>Upward Total</b>	<b>211.8</b>	<b>0.5%</b>
<b>Total Lumens:</b>	<b>42063.6</b>	<b>100%</b>

Max Cd, 90° Vertical: 101.6

Max Cd, 80 to <90°: 1112.8

	Lumens	% Lamp
Downward Street Side	29299.3	70.1%
Downward House Side	12361.0	29.6%
<b>Downward Total</b>	<b>41660.3</b>	<b>99.7%</b>
Upward Street Side	59.8	0.1%
Upward House Side	68.9	0.2%
<b>Upward Total</b>	<b>128.7</b>	<b>0.3%</b>
<b>Total Lumens:</b>	<b>41789.1</b>	<b>100%</b>

Max Cd, 90° Vertical: 55.5

Max Cd, 80 to <90°: 8698.9

	Lumens	% Lamp
Downward Street Side	21359.8	50.7%
Downward House Side	20602.8	48.9%
<b>Downward Total</b>	<b>41962.6</b>	<b>99.6%</b>
Upward Street Side	93.8	0.2%
Upward House Side	81.9	0.2%
<b>Upward Total</b>	<b>175.7</b>	<b>0.4%</b>
<b>Total Lumens:</b>	<b>42138.2</b>	<b>100%</b>

**FLOOD SUMMARY**

	Efficacy	Lumens	Horiz. Spread	Vert. Spread
Field (10%)	97.9%	41185.6	158.8	151.7
Beam (50%)	80.4%	33810.9	139.1	111.2
<b>Total</b>	<b>100%</b>	<b>42044.3</b>		

	Efficacy	Lumens	Horiz. Spread	Vert. Spread
Field (10%)	98.5%	41180.3	158.3	143.6
Beam (50%)	82.7%	34573.9	146.1	105.9
<b>Total</b>	<b>99.9%</b>	<b>41757.4</b>		

	Efficacy	Lumens	Horiz. Spread	Vert. Spread
Field (10%)	99.1%	41748.5	142.1	162.7
Beam (50%)	90.0%	37943.1	126.7	153.4
<b>Total</b>	<b>99.9%</b>	<b>42099.8</b>		

**ILLUMINANCE**

Height	Center Beam fc	Beam Width	
17.0 ft	37.0 fc	49.7 ft	91.2 ft
34.0 ft	9.26 fc	99.4 ft	182.5 ft
51.0 ft	4.12 fc	149.1 ft	273.7 ft
68.0 ft	2.32 fc	198.8 ft	365.0 ft
85.0 ft	1.48 fc	248.5 ft	456.2 ft
102.0 ft	1.03 fc	298.1 ft	547.5 ft
		Vert. 111.2°	Horiz. 139.1°

Height	Center Beam fc	Beam Width	
17.0 ft	32.1 fc	45.0 ft	111.7 ft
34.0 ft	8.02 fc	90.0 ft	223.3 ft
51.0 ft	3.56 fc	135.0 ft	335.0 ft
68.0 ft	2.00 fc	180.0 ft	446.7 ft
85.0 ft	1.28 fc	225.0 ft	558.4 ft
102.0 ft	0.89 fc	270.0 ft	670.0 ft
		Vert. 105.9°	Horiz. 146.1°

Height	Center Beam fc	Beam Width	
17.0 ft	14.8 fc	143.7 ft	67.8 ft
34.0 ft	3.71 fc	287.3 ft	135.6 ft
51.0 ft	1.65 fc	431.0 ft	203.4 ft
68.0 ft	0.93 fc	574.6 ft	271.2 ft
85.0 ft	0.59 fc	718.3 ft	339.0 ft
102.0 ft	0.41 fc	861.9 ft	406.8 ft
		Vert. 153.4°	Horiz. 126.7°

**YES LED Area Light**



YES-A09-300W-HY-5000K (277V)

Distribution: Nema Type III, Short, Cutoff

Lamp Output: 51924.3 lumens

Max Candela: 17128.4 at Horizontal: 67.5°, Vertical: 58°

Input Wattage: 299.76

Nema Type: 7 X 7

BUG: B5 U3 G4

Distribution: Nema Type IV, Very Short, Non-Cutoff

Lamp Output: 51735.7 lumens

Max Candela: 16236.7 at Horizontal: 0°, Vertical: 49°

Input Wattage: 300.42

Nema Type: 7 X 7

BUG: B4 U3 G5

Distribution: Nema Type V, Very Short, Non-Cutoff

Lamp Output: 52017.6 lumens

Max Candela: 13815.3 at Horizontal: 225°, Vertical: 72°

Input Wattage: 298.53

Nema Type: 7 X 7

BUG: B5 U3 G5

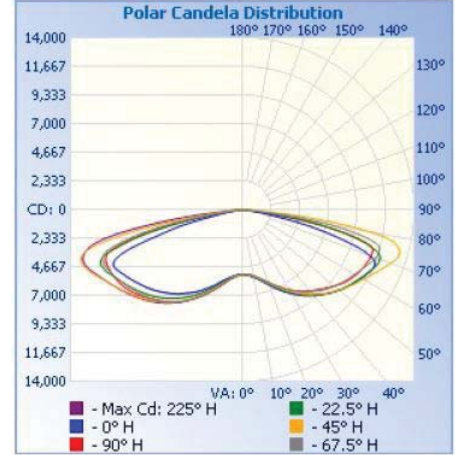
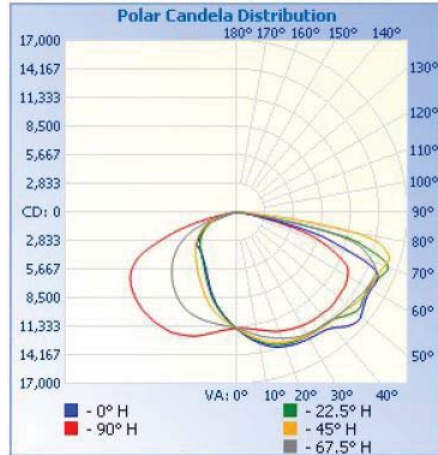
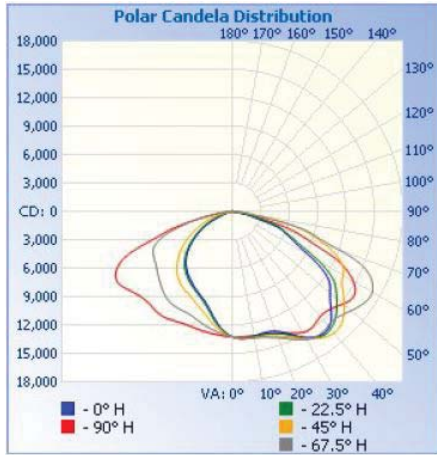

ROADWAY SUMMARY

Max Cd, 90° Vertical: 507.9

Max Cd, 80 to <90°: 4499.6

Table with 3 columns: Direction, Lumens, % Lamp

Max Cd, 90° Vertical: 59.3

Max Cd, 80 to <90°: 12167.9

Table with 3 columns: Direction, Lumens, % Lamp

Max Cd, 90° Vertical: 66.9

Max Cd, 80 to <90°: 10761.1

Table with 3 columns: Direction, Lumens, % Lamp

FLOOD SUMMARY

Table with 5 columns: Efficacy, Lumens, Horiz. Spread, Vert. Spread

Table with 5 columns: Efficacy, Lumens, Horiz. Spread, Vert. Spread

Table with 5 columns: Efficacy, Lumens, Horiz. Spread, Vert. Spread

ILLUMINANCE

Table with 4 columns: Height, Center Beam fc, Beam Width, Vert. Spread

Table with 4 columns: Height, Center Beam fc, Beam Width, Vert. Spread

Table with 4 columns: Height, Center Beam fc, Beam Width, Vert. Spread



YES-A08-300W-HY-HV-5000K (480V)

Distribution: Nema Type III, Short, Cutoff

Lamp Output: 51798.7 lumens

Max Candela: 17100.6 at Horizontal: 67.5°, Vertical: 59°

Input Wattage: 297.54

Nema Type: 7 X 7

BUG: B5 U3 G4

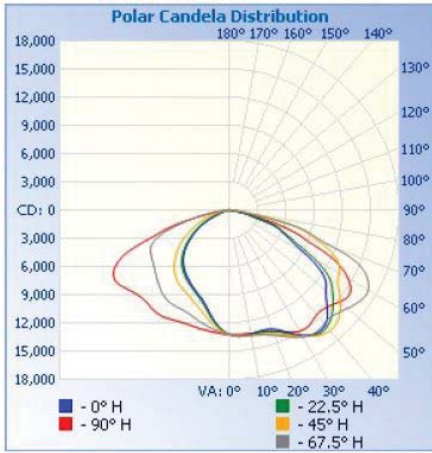

Distribution: Nema Type IV, Very Short, Non-Cutoff

Lamp Output: 51672.5 lumens

Max Candela: 16216.9 at Horizontal: 0°, Vertical: 49°

Input Wattage: 298.93

Nema Type: 7 X 7

BUG: B4 U3 G5

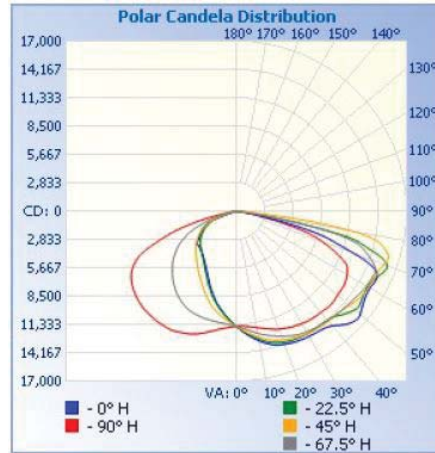

Distribution: Nema Type V, Very Short, Non-Cutoff

Lamp Output: 52051.2 lumens

Max Candela: 13831.3 at Horizontal: 225°, Vertical: 72°

Input Wattage: 296.95

Nema Type: 7 X 7

BUG: B5 U3 G5

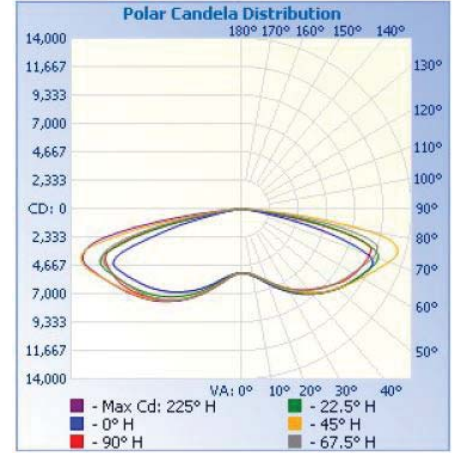

ROADWAY SUMMARY

Max Cd, 90° Vertical: 503.4

Max Cd, 80 to <90°: 4345.8

Table with 3 columns: Lumens, % Lamp, and rows for Downward/Upward Street/House Side and Totals.

Max Cd, 90° Vertical: 59.2

Max Cd, 80 to <90°: 12153.0

Table with 3 columns: Lumens, % Lamp, and rows for Downward/Upward Street/House Side and Totals.

Max Cd, 90° Vertical: 75.4

Max Cd, 80 to <90°: 10691.6

Table with 3 columns: Lumens, % Lamp, and rows for Downward/Upward Street/House Side and Totals.

FLOOD SUMMARY

Table with 5 columns: Efficacy, Lumens, Horiz. Spread, Vert. Spread, and rows for Field (10%), Beam (50%), and Total.

Table with 5 columns: Efficacy, Lumens, Horiz. Spread, Vert. Spread, and rows for Field (10%), Beam (50%), and Total.

Table with 5 columns: Efficacy, Lumens, Horiz. Spread, Vert. Spread, and rows for Field (10%), Beam (50%), and Total.

ILLUMINANCE

Table with 4 columns: Height, Center Beam fc, Beam Width, and rows for 17.0 ft to 102.0 ft.

Table with 4 columns: Height, Center Beam fc, Beam Width, and rows for 17.0 ft to 102.0 ft.

Table with 4 columns: Height, Center Beam fc, Beam Width, and rows for 17.0 ft to 102.0 ft.

YES LED Area Light



FLICKER RATING

YES-A02-100W-HY-XXXXK (277V)

Table with 9 columns: Frequency, MOD (no-effect), MOD (low-risk), 100% dim, 90% dim, 75% dim, 50% dim, 20% dim, 10% dim. Rows for 40 Hz, 90 Hz, 200 Hz, 400 Hz, 1000 Hz.

YES-A01-100W-HY-HV-XXXXK (480V)

Table with 9 columns: Frequency, MOD (no-effect), MOD (low-risk), 100% dim, 90% dim, 75% dim, 50% dim, 20% dim, 10% dim. Rows for 40 Hz, 90 Hz, 200 Hz, 400 Hz, 1000 Hz.

YES-A04-150W-HY-XXXXK (277V)

Table with 9 columns: Frequency, MOD (no-effect), MOD (low-risk), 100% dim, 90% dim, 75% dim, 50% dim, 20% dim, 10% dim. Rows for 40 Hz, 90 Hz, 200 Hz, 400 Hz, 1000 Hz.

YES-A03-150W-HY-HV-XXXXK (480V)

Table with 9 columns: Frequency, MOD (no-effect), MOD (low-risk), 100% dim, 90% dim, 75% dim, 50% dim, 20% dim, 10% dim. Rows for 40 Hz, 90 Hz, 200 Hz, 400 Hz, 1000 Hz.

YES-A05-200W-HY-XXXXK (277V)

Table with 9 columns: Frequency, MOD (no-effect), MOD (low-risk), 100% dim, 90% dim, 75% dim, 50% dim, 20% dim, 10% dim. Rows for 40 Hz, 90 Hz, 200 Hz, 400 Hz, 1000 Hz.

YES-A06-240W-HY-HV-XXXXK (480V)

Table with 9 columns: Frequency, MOD (no-effect), MOD (low-risk), 100% dim, 90% dim, 75% dim, 50% dim, 20% dim, 10% dim. Rows for 40 Hz, 90 Hz, 200 Hz, 400 Hz, 1000 Hz.

YES-A07-240W-HY-XXXXK (277V)

Table with 9 columns: Frequency, MOD (no-effect), MOD (low-risk), 100% dim, 90% dim, 75% dim, 50% dim, 20% dim, 10% dim. Rows for 40 Hz, 90 Hz, 200 Hz, 400 Hz, 1000 Hz.

YES-A09-300W-HY-XXXXK (277V)

Table with 9 columns: Frequency, MOD (no-effect), MOD (low-risk), 100% dim, 90% dim, 75% dim, 50% dim, 20% dim, 10% dim. Rows for 40 Hz, 90 Hz, 200 Hz, 400 Hz, 1000 Hz.

YES-A08-300W-HY-HV-XXXXK (480V)

Table with 9 columns: Frequency, MOD (no-effect), MOD (low-risk), 100% dim, 90% dim, 75% dim, 50% dim, 20% dim, 10% dim. Rows for 40 Hz, 90 Hz, 200 Hz, 400 Hz, 1000 Hz.

Reference Standard IEEE 1789: 2015



## SURGE PROTECTION

## YES-A02-100W-HY-XXXXK (277V)

Test Items	Surge /kv	Interval time/S	Times	Process phenomenon	Criteria	Result
L-N	±3	60	5	Normal	B	Pass
L-N	±6.6	60	5	Normal	B	Pass
L-PE/N-PE	±5	60	5	Normal	B	Pass
L-PE/N-PE	±10	60	5	Normal	B	Pass

## YES-A04-150W-HY-XXXXK (277V)

Test Items	Surge /kv	Interval time/S	Times	Process phenomenon	Criteria	Result
L-N	±3	60	5	Normal	B	Pass
L-N	±6.6	60	5	Normal	B	Pass
L-PE/N-PE	±5	60	5	Normal	B	Pass
L-PE/N-PE	±10	60	5	Normal	B	Pass

## YES-A05-200W-HY-XXXXK (277V)

Test Items	Surge /kv	Interval time/S	Times	Process phenomenon	Criteria	Result
L-N	±3	60	5	Normal	B	Pass
L-N	±6.6	60	5	Normal	B	Pass
L-PE/N-PE	±5	60	5	Normal	B	Pass
L-PE/N-PE	±10	60	5	Normal	B	Pass

## YES-A07-240W-HY-XXXXK (277V)

Test Items	Surge /kv	Interval time/S	Times	Process phenomenon	Criteria	Result
L-N	±3	60	5	Normal	B	Pass
L-N	±6.6	60	5	Normal	B	Pass
L-PE/N-PE	±5	60	5	Normal	B	Pass
L-PE/N-PE	±10	60	5	Normal	B	Pass

## YES-A09-300W-HY-XXXXK (277V)

Test Items	Surge /kv	Interval time/S	Times	Process phenomenon	Criteria	Result
L-N	±3	60	5	Normal	B	Pass
L-N	±6.6	60	5	Normal	B	Pass
L-PE/N-PE	±5	60	5	Normal	B	Pass
L-PE/N-PE	±10	60	5	Normal	B	Pass

## YES-A01-100W-HY-HV-XXXXK (480V)

Test Items	Surge /kv	Interval time/S	Times	Process phenomenon	Criteria	Result
L-N	±3	60	5	Normal	B	Pass
L-N	±6.6	60	5	Normal	B	Pass
L-PE/N-PE	±6.6	60	5	Normal	B	Pass
L-PE/N-PE	±10	60	5	Normal	B	Pass

## YES-A03-150W-HY-HV-XXXXK (480V)

Test Items	Surge /kv	Interval time/S	Times	Process phenomenon	Criteria	Result
L-N	±3	60	5	Normal	B	Pass
L-N	±6.6	60	5	Normal	B	Pass
L-G	±6.6	60	5	Normal	B	Pass
L-G	±12	60	5	Normal	B	Pass
N-G	±6.6	60	5	Normal	B	Pass
N-G	±12	60	5	Normal	B	Pass

## YES-A06-240W-HY-HV-XXXXK (480V)

Test Items	Surge /kv	Interval time/S	Times	Process phenomenon	Criteria	Result
L-N	±3	60	5	Normal	B	Pass
L-N	±6.6	60	5	Normal	B	Pass
L-PE/N-PE	±5	60	5	Normal	B	Pass
L-PE/N-PE	±10	60	5	Normal	B	Pass

## YES-A08-300W-HY-HV-XXXXK (480V)

Test Items	Surge /kv	Interval time/S	Times	Process phenomenon	Criteria	Result
L-N	±3	60	5	Normal	B	Pass
L-N	±6.6	60	5	Normal	B	Pass
L-PE/N-PE	±5	60	5	Normal	B	Pass
L-PE/N-PE	±10	60	5	Normal	B	Pass

Reference Standard IEC 61000-4-5

- Testing Criteria B: Temporary loss of function or degradation of performance and recover its normal performance without operator intervention.

## Smart Sensors & Remotes

Remote Program Smart Sensor functions to automate and control sensitivity and brightness levels for photocell, daylight, standby dimming, and motion detection.

### TECHNICAL DATA

<b>Operating Voltage</b>	10-15VDC
<b>Operating Current</b>	30mA±5%
<b>Output</b>	0-10V
<b>Standby Power</b>	≤0.5W
<b>Detection Area</b>	25%, 50%, 75%, 100%
<b>Hold Time</b>	5 sec, 30 sec, 1 min, 3 min, 5 min, 10 min, 20 min, 30 min
<b>Daylight Threshold</b>	2Lux, 10Lux, 30Lux, 50Lux, 80Lux, 120Lux, Disable
<b>Standby Period</b>	0 sec, 10 sec, 30 sec, 1 min, 5 min, 10 min, 30 min, + ∞
<b>Standby Dimming Level</b>	10%, 20%, 30%, 50%
<b>Microwave Frequency</b>	5.8GHz±75MHz
<b>Microwave Power</b>	<0.3mW
<b>Mounting Height</b>	49.2 FT Max Height
<b>Detection Range</b>	Max, Ø 45.92 FT
<b>Operating Temperature</b>	-4°F to 140°F (-20°C to 60°C)
<b>Motion Detection</b>	0.5~1.5 m/s
<b>IP Rating</b>	IP65 Wet Location
<b>Warranty</b>	5 Years

### DETECTION RANGE

Detection range shown in feet of ProGem LED Area Light installed at the maximum height of 49.2 FT.

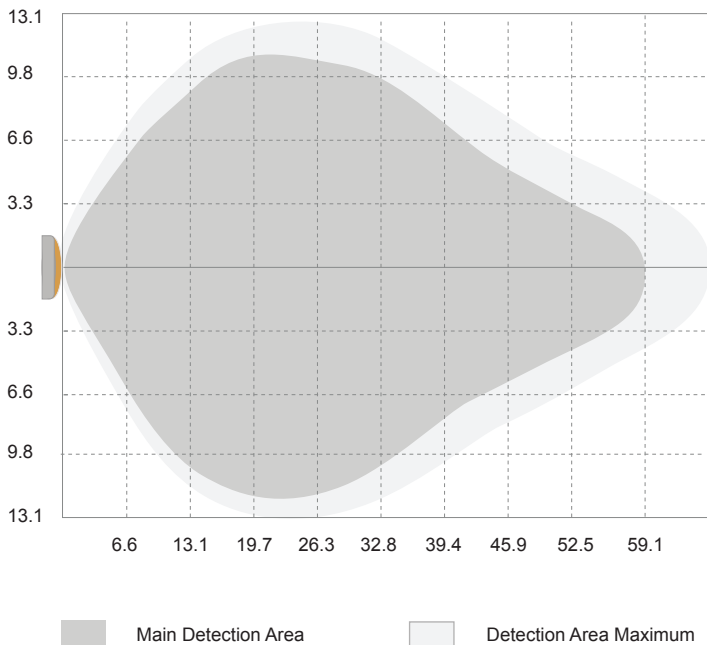

Project:
Date:
Catalog No:
Prepared By:

### ALPCSG2

#### Photocell Sensor

Translucent Black Cap With Round Chipset



### ALMSPCSG2

#### Photocell, Daylight, Standby Dimming, and Motion Sensor

Translucent Black Cap With Round and Rectangular Chipsets



### SC

#### Shorting Cap, No Sensor

Translucent Black Cap Only With No Chipset



### PHYSICAL DIMENSIONS

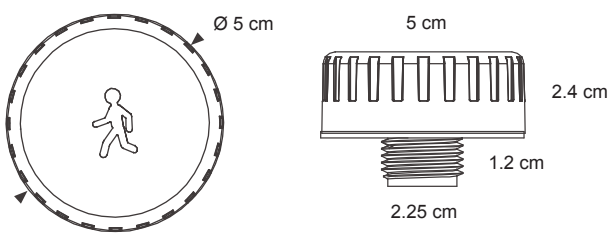



**ALRM-HD03R REMOTE**



\*Uses 2X AAA Batteries, Not Included

**ALRM-HD05R REMOTE**



\*Uses 2X AAA Batteries, Not Included

**USER GUIDE**

1. Press the red ON/OFF button to turn on the luminaire.
2. Press the START button:
  - Press button values for: a) Detection Range, b) Hold Time, c) Standby Dimming Level, d) Standby Time, e) Daylight Sensor
  - Press and hold arrow buttons to adjust the luminaire's maximum Brightness Level.
    - \* Each selection will flash the red indicator light and momentarily dim the luminaire to communicate the setting.
3. Press the MEMORY button to store current settings in the remote.
4. Press the APPLY button, the green indicator light will flash and the luminaire will momentarily dim to save its new settings.

**TO APPLY STORED SETTINGS TO ADDITIONAL LUMINAIRES:**

1. Press the ON/OFF power button to turn on the next luminaire.
2. Press the APPLY button, the green indicator light will flash and the luminaire will momentarily dim to store the new settings.

**NOTES**

- Securely twist-on the Smart Sensor Cap and install the luminaire with the lighting system's power OFF. Program settings to the luminaire with the lighting system's power ON.
- Point the Remote towards the Smart Sensor throughout setting program functions. Settings must be applied within 30 seconds of pressing the Start button.

**USER GUIDE**

1. Press the red ON/OFF power button to turn on the luminaire.
2. Press the SCENE button.
3. Press the START button:
  - Press MW/PIR to select between Microwave or Passive Infrared frequencies
  - Press an Icon button and use Arrow buttons to select a value. Repeat for a) Detection Range, b) Hold Time, c) Standby Dimming Level, d) Standby Time, e) Daylight Sensor
  - Press the Power % and use the Arrow buttons to adjust the luminaire's maximum Brightness Level.
    - \* Each selection will momentarily dim the luminaire to communicate the setting.
4. Press the MEMORY button to store current settings in the remote.
5. Press the APPLY button, the luminaire will momentarily dim to save its new settings.

**TO APPLY STORED SETTINGS TO ADDITIONAL LUMINAIRES:**

1. Press the ON/OFF power button to turn on the next luminaire.
2. Press the SCENE button.
3. Press the APPLY button, the green indicator light will flash and the luminaire will momentarily dim to store the new settings.

**RECALL THE PREVIOUSLY STORED SETTINGS:**

1. Press the ON/OFF power button to turn on the screen.
2. Press the SCENE button, Brightness will show less than 100%.
3. Press the APPLY button and the previously saved settings will appear.

**NOTES**

- Securely twist-on the Smart Sensor Cap and install the luminaire with the lighting system's power OFF. Program settings to the luminaire with the lighting system's power ON.
- Point the Remote towards the Smart Sensor throughout setting program functions. Settings must be applied within 30 seconds of pressing the Start button.